



# F-104G interior S.A.

eduard

32 803

1/32 scale detail set for Italeri kit • sada detailů pro model 1/32 Italeri

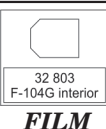
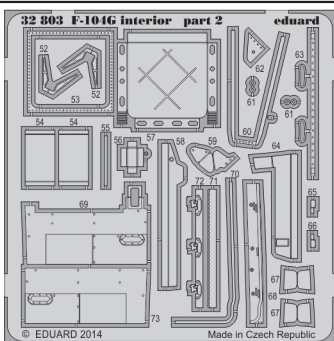
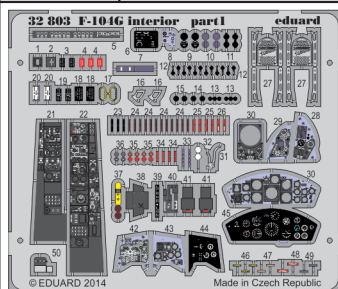

- APPLY EXPRESS MASK AND PAINT BEFORE GLUING  
POUŽIT EXPRESS MASK NABARVIT PŘED SLEPENÍM
- SYMMETRICAL ASSEMBLY  
SYMETRICKÁ MONTÁŽ
- REMOVE  
ODSTRANIT
- GRIND  
OBROUSIT
- DRILL HOLE  
VRTAT OTVOR
- COLORED ETCHED PARTS  
LEPTANÉ BAREVNÉ DÍLY
- BEND  
OHNOUT
- OPTION  
VOLBA
- REPLACE  
NAHRADIT

ORIGINAL KIT PARTS  
PŮVODNÍ DÍLY STAVEBNICE

PHOTO-ETCHED PARTS  
LEPTANÉ DÍLY

PARTS TO BE REMOVED  
DÍLY K ODSTRANĚNÍ

FILL  
TMELIT

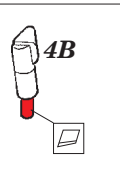
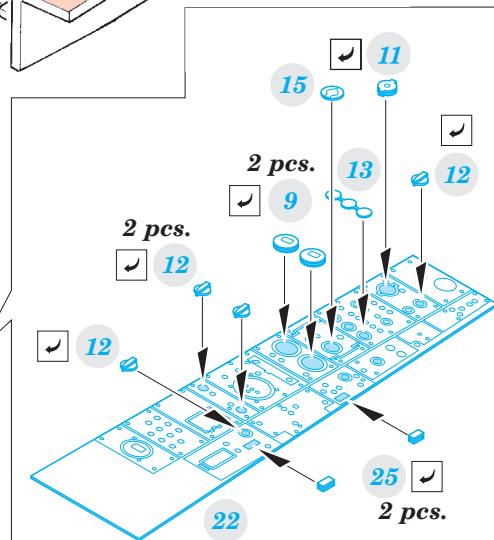
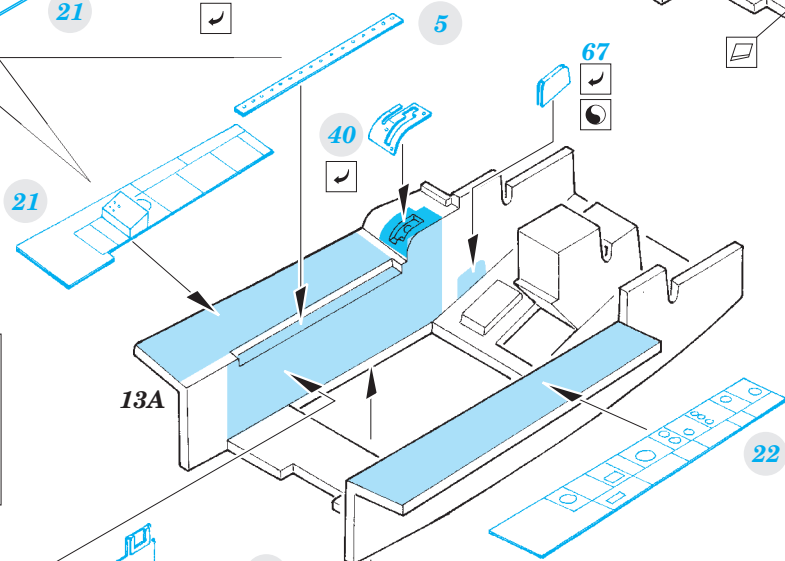
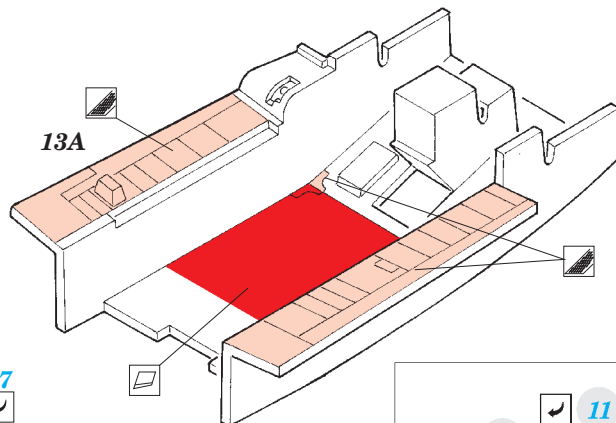
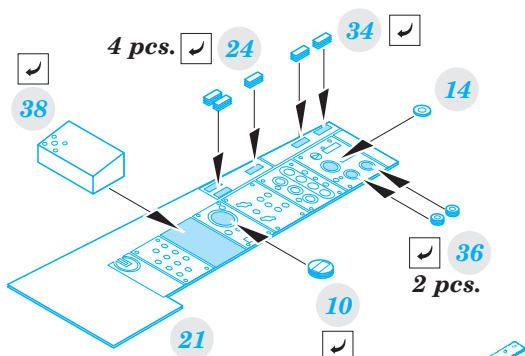

Do not use for version with the seat C-2

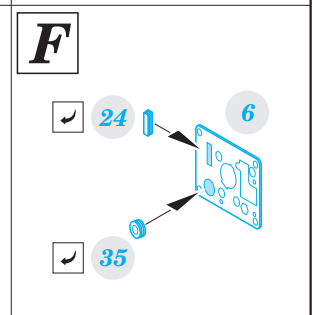
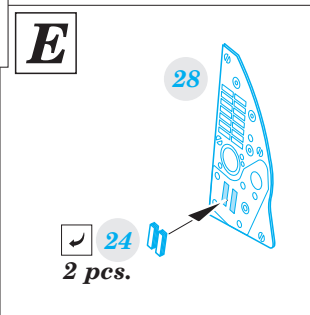
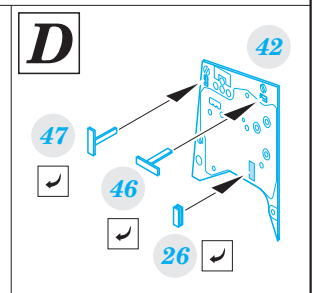
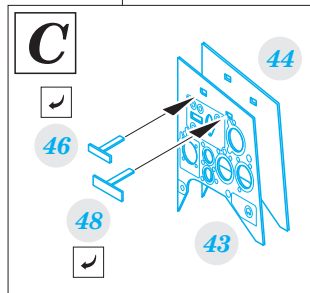
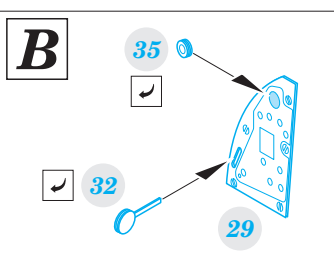
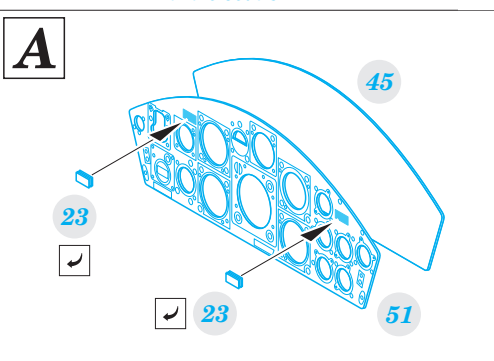

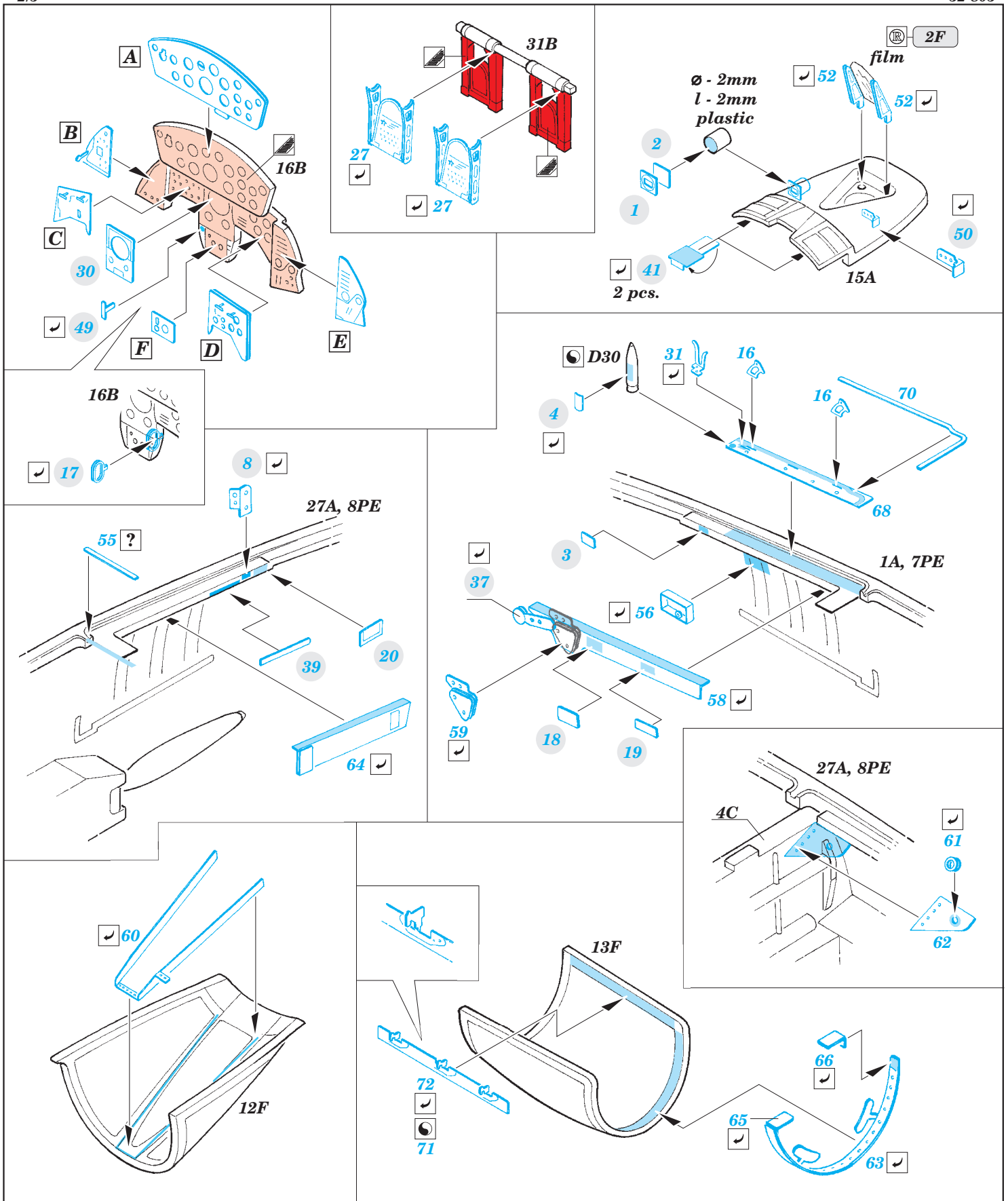

**For further detail sets look for eduard 32 805 F-104 seatbelts  
(not included in this set)**

**For further detail sets look for eduard 32 811 F-104 undercarriage  
(not included in this set)**

**For further detail sets look for eduard 32 348 F-104G exterior  
(not included in this set)**

## PARTS WITH GLUE • DÍLY OPATŘENÉ LEPIDLEM

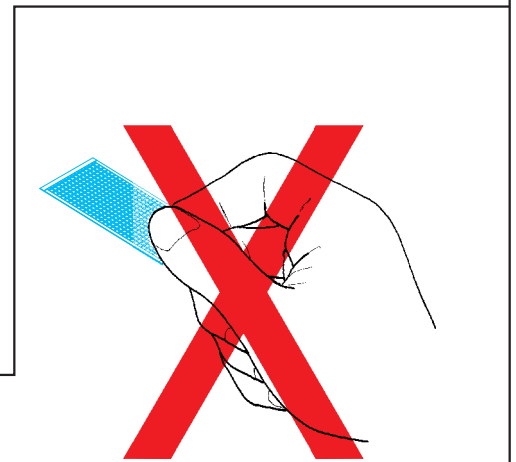
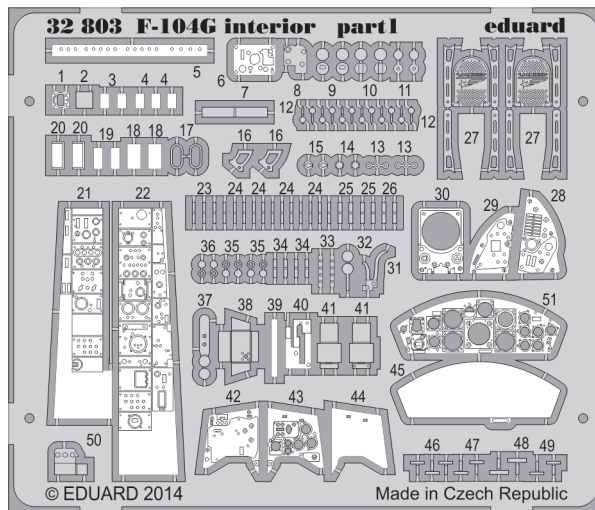

1. Separate the etched components from their frames on the protective paper. Removal from the paper is done only after separation of the parts from the frames.

1. Samolepicí díly oddělujte od rámečku na podkladovém papíře. Po oddělení je sejměte z krycího papíru.

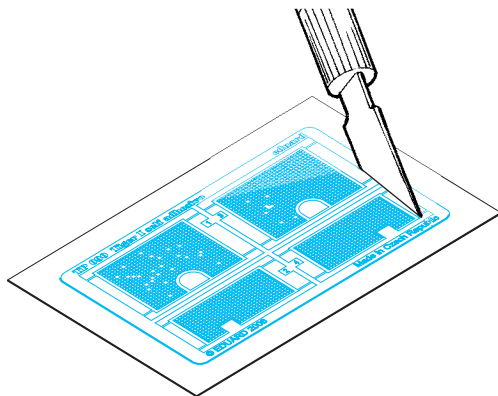

2. Do not inadvertently place etched components on an unwanted surface. Attempts to remove will result in damage to your part.

2. Nepokládejte samolepicí díly na volné plochy. Pokud je omylem přilepíte, při pokusu o odlepení dojde k poškození dílu.

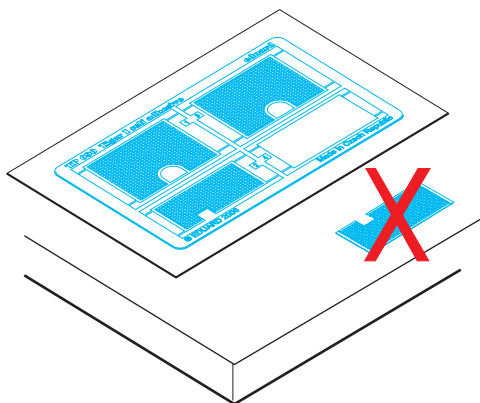

3. Do not touch the adhesive areas of the etched components.

3. Nesahejte na části dílů, na kterých je naneseno lepidlo.

4. Hold the parts by the edges, or at areas free of adhesive.

4. Samolepicí díly berte za hrany nebo za části, na kterých není nanesené lepidlo.

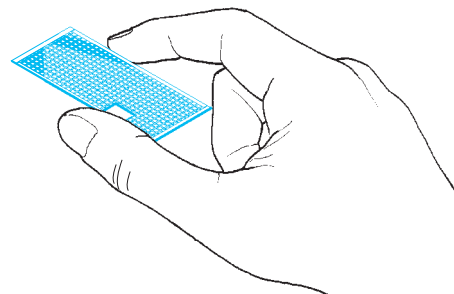

5. Lightly place the component in the desired location and position. Adjust as required. The component will be permanently affixed when pressed onto its intended location, its location can be adjusted.

5. Díl lehce položte do pozice, ve které má být nalepen. Upravte přesnou pozici a přimáčkněte. Díl dokonale přilne až po přimáčknutí, před přimáčknutím lze dílem opatrně manipulovat.

