

eduard
MASK

F-16C Block 25 Fighting Falcon 1/48

The die-cut mask for accurate canopy frame painting of the
Tamiya scale 1/48 KIT

EX 252

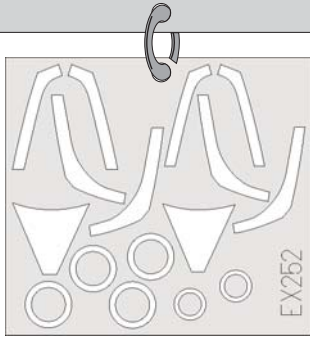

R10, R11

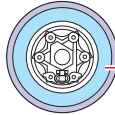

R9
2pcs

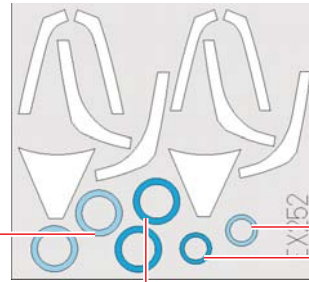
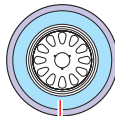

J11

LIQUID MASK
MASCOL

1.)

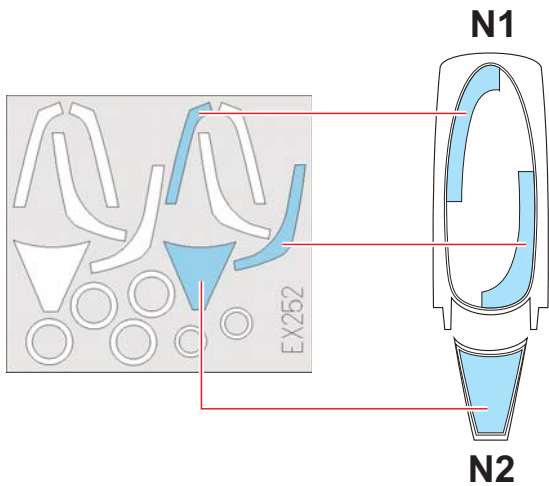

2.)

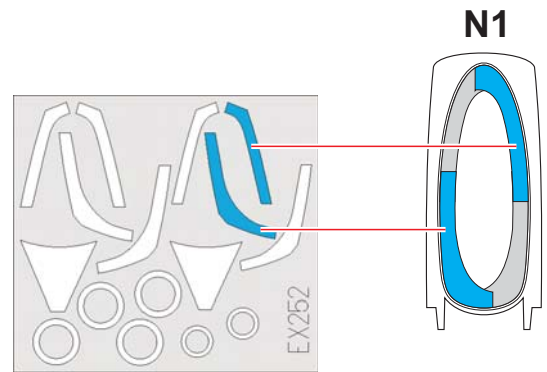

3.)



INTERIOR COLOR
BARVA INTERIÉRU

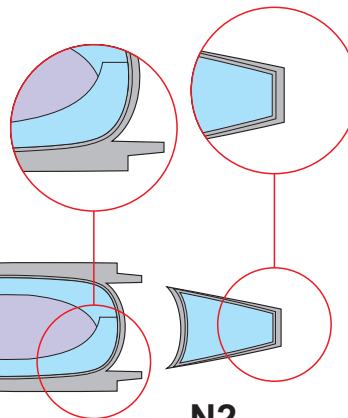

N1

N2

4.)



RUBBER COLOR
BARVA GUMY



LIQUID MASK
MASCOL

5.)

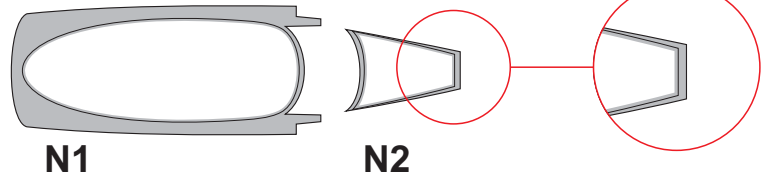
REMOVE MASK
ODSTRANIT MASKU

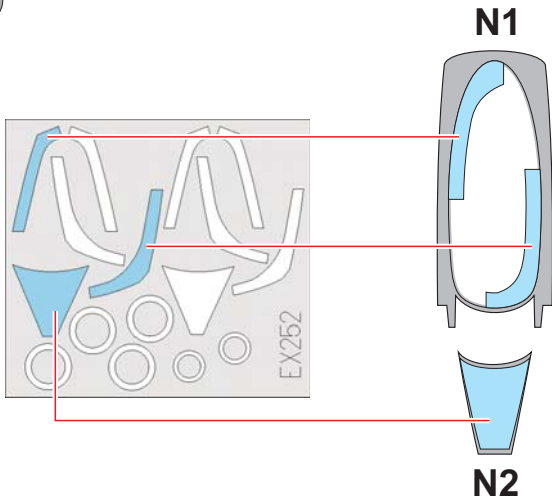

6.)



7.)

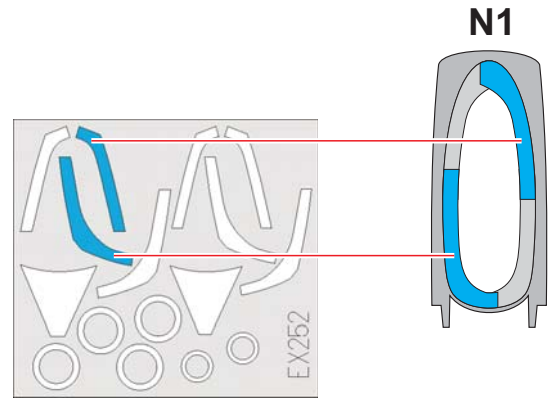

8.)

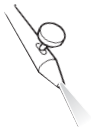

CAMOUFLAGE COLOR
BARVA KAMUFLÁŽE

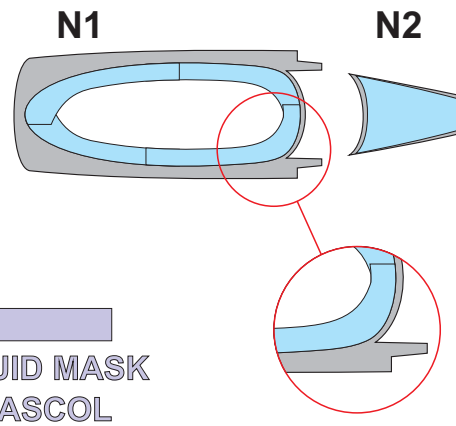

9.)

REMOVE MASK
ODSTRANIT MASKU

